

Diritti riservati All rights reserved

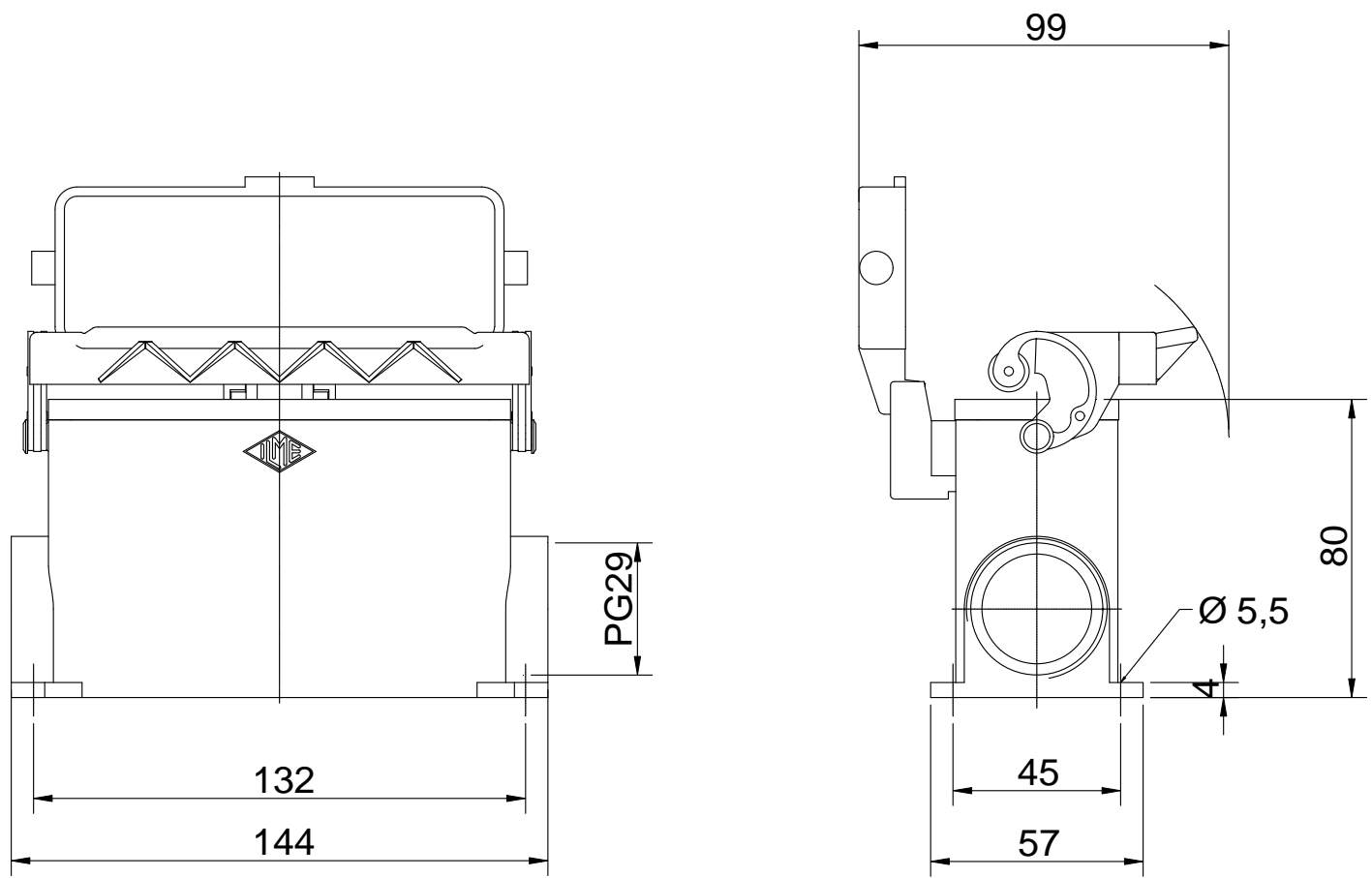

Date 04.01.2007	CMAP 16 LS29		Scale
Sign.	surface mount.h. 1 lev.+cover PG29 ins.		1:2